

General Guide for Accurate Weighing with Portable Wheel Load Scales

Date: (a) 8.8.97 (b) 10.8.00 (c) 13.2.02 (d) 22.5.02 (e) 5.11.08
 (f) 3.1.11 (g) 15.7.13

Author: F. Scheuter

Visa:



<u>Contents</u>	<u>Page</u>
1. General	1
2. Configuration	1
2.1. Measuring modes	1
2.2. Levelling	1
2.3. Configuration according to task	1
3. Error influences	2
3.1. General	2
3.2. Error of the scale	3
3.2.1. The scale accuracy	3
3.2.2. Verifying the scale accuracy	4
3.3. Errors caused by „external factors“	5
3.3.1. Tilting	5
3.3.2. The vehicle suspension (spring constant)	7
3.3.3. Friction in the suspension	7
3.3.4. Brake reaction forces	7
3.3.5. Vehicle oscillation	8
3.3.6. Site unevenness	8
4. Weighing in practice	8

This paper consists of page E0...E10

1. General

This paper covers the general issues when using portable wheel load scales. It is considered to be a supplementary information to the manual of the scale.

2. Configuration

2.1. Measuring modes

There are three modes for measuring with portable wheel load scales:

1. In one operation with the same number of scales as wheels (static scales only)
2. Consecutive weighing axle by axle (static and dynamic)
3. Combination of the above modes (static scales only)

2.2. Levelling

If the vehicle is not measured in one operation, levelling mats may be necessary. Its purpose is to lift a non weighed axle to the level of the scale platform. In which cases levelling mats must be used is explained later. Two types of levelling mats are available:

- small: same size as the scale platform (static scales only)
- large: 2.8 m long. 0.87 m wide

2.3. Configuration according to the task

According to the purpose of the weighing the appropriate configuration should be chosen.

Hereafter is a list with typical applications and the appropriate configuration:

- **High accuracy** (static scales only): Weighing in one operation with the **same number of scales as wheels** or at least weighing of axle groups in one operation (six scales). Improvement of the accuracy by using scales with a smaller division (higher accuracy). **Operation:** The vehicle is stopped, the scales are placed in close proximity to the wheels. The vehicle is driven onto the scales.
- **Large Number of vehicles** measured in a short time: Axle by axle using **two scales and four large levelling mats**, two in front and two behind the scales. Use of a processing unit or a Personal Computer for ticket printout. Only limited improvement of the accuracy when using scales with a smaller division. **Operation:** The system is placed on the measuring site in „H-form“. The vehicle is guided by markings (cones) in front and behind the measuring system. The axles are driven subsequently onto the scales. The scales may have to be adjusted slightly to ensure that the wheels are well within the active surface.
- Measuring of individual vehicles at any place with minimum equipment (spot checks, static scales only): **two scales and four small levelling mats**. Only limited improvement of the accuracy when using scales with a smaller division. **Operation:** The vehicle is stopped, the scales and the levelling mats are placed in close proximity to the wheels. The vehicle is driven onto the scales consecutively, until all wheels are measured.

For detailed information regarding accuracy and comfort refer to section 4.

3. Error influences

3.1. General

The error of a weighing with portable wheel load scales has two sources: the **scale** itself and the so called „**external factors**“.

The **error of the scale** is obviously the **difference** between the **indication** and the **load** placed on the platform. It can be determined on a suitable test machine or by special test procedures using a approved platform scale. All influence factors like temperature, eccentric load, tilted condition, bent through, repeatability, creep, warm up, damp heat, span stability, EMC, can be simulated.

Usually the test of a wheel load scale is divided into two parts: The type approval and the test before putting into operation.

Type approval: One or more samples are tested under laboratory conditions to find out the performance of the measuring system. The procedure consists of many tests to prove that the indication is correct under all above mentioned conditions.

Putting into operation: The wheel load scale to be put into operation is tested under laboratory conditions at ambient temperature at least at one location of the platform, preferably in the centre. Depending on the results of the type approval other tests may also be demanded by the testing authority, e.g. with eccentric load.

The **external factors** are defined as the influences which make **a wheel or axle load lower or higher than it would be under perfect conditions**. The perfect condition is: absolutely **level site**, all **suspensions** of the vehicle in an **average, frictionless position**, **no braking**, **no vehicle oscillation**. This definition shows, that the external factors **have nothing to do with the scale accuracy**. Or in other words; the scale only can measure what it „**feels**“.

Depending on the configuration used the influence of the external factors is zero (gross weight determined in one operation), or in the worst case (weighing vehicles in poor maintenance condition axle by axle on an unfavorable site) the influence is definitely higher than the error of the scale.

When using a portable weighing system the expected external factors have to be taken into consideration. **The more wheel load scales are used the higher the over all accuracy is**. A system with only two scales and 4 levelling mats is very convenient to operate, but it is most sensitive for errors due to external factors.

The following list shows the possible range of the external errors when determining the axle load:

Two axle truck, any vehicle and site condition but horizontal site in driving direction, static:	1%
Vehicles with double and triple axle systems in good condition on a good site, static	2%
Vehicles with double and triple axle systems in poor condition on a poor site, static	5%
Any vehicle in good condition on a good site, dynamic at 2 km/h	2%
Any vehicle in poor condition on a poor site, dynamic at 10 km/h	10%

In many applications the use of tolerance deductions is a good approach to be on the „safe side“.

If the **weighing errors in practice are bigger than expected** it is recommended to check first the accuracy of the scale in order to determine whether the **scale** or the **external factors** are the source of the weighing errors.

In order to avoid external errors as much as possible the following measures can be taken:

- Selection of a **even and flat site** which is horizontal in the driving direction to eliminate load shift (3.3.1), errors due to the vehicle suspension (3.3.2) and to vehicle oscillations (3.3.5).
- Use of **levelling mats** to eliminate errors due to the vehicle suspension (3.3.2) and to vehicle oscillations (3.3.5).
- **Stopping the vehicle smoothly** on the static scale and releasing the brake completely when taking the reading to eliminate errors due to brake reaction forces (3.3.4) and friction (3.3.3).
- **Making sure that the wheels are well within the active surface of the scale.**

For accurate results the following parties are responsible:

- The *manufacturer* for the *quality and accuracy of the scales.*
- The *operator* for *proper use* according to the manual of the scale and for the selection of a *flat and even weighing site.*
- Usually *nobody feels responsible* for the *weighing errors caused by the vehicle* as long as it fulfills the requirements of the organization in charge for vehicle inspection. Neither the manufacturer nor the user can influence the quality and the maintenance condition of the vehicles. But its *influence can be minimized by following the above recommendations.*

3.2. Errors of the scale

3.2.1. The scale accuracy

The accuracy of the scale is stated in the data sheet and in the manual. The acceptance tolerance applies to tests under laboratory conditions before putting into operation. The maintenance tolerance, which is usually double the acceptance tolerance, applies for annual verification and for field tests.

3.2.2. Verifying the scale accuracy

A full and unambiguous test is possible only on an approved test machine. Refer to P 1133 for more details. But there are also good possibilities for **checking the accuracy** of the scale itself **on site**.

Swapping the scales:

The approximate precision of the scale can be determined by weighing a single axle with two scales. After the first weighing is made, swap the scales left to right and repeat the process. The individual wheel as well as axle weights should agree from the first to the second weighing. The instructions in the operating manual must be followed strictly.

Testing on a platform scale:

Principle: Comparison of the indication of the Wheel Load Scale with the indication of an approved weigh bridge with different loads (Different vehicles, front and rear wheel, loaded and unloaded).

The weigh bridge has to be tarred with the Wheel Load Scale, or the weight of the Wheel Load Scale must be deducted from the indication of the weigh bridge.

Different loads may be applied by repeating the test with the rear axle wheels and by using different vehicles and different loading conditions.

The Error of the Wheel Load Scale is: [indication Wheel Load Scale] - [indication Weigh bridge]

Due to the fact that it is a field test, the error must be within the maintenance tolerance.

For static scales:

This method **excludes all error influences** due to **unfavourable vehicle and site quality** (friction in the suspension, brake reaction forces, tilting, site unevenness).

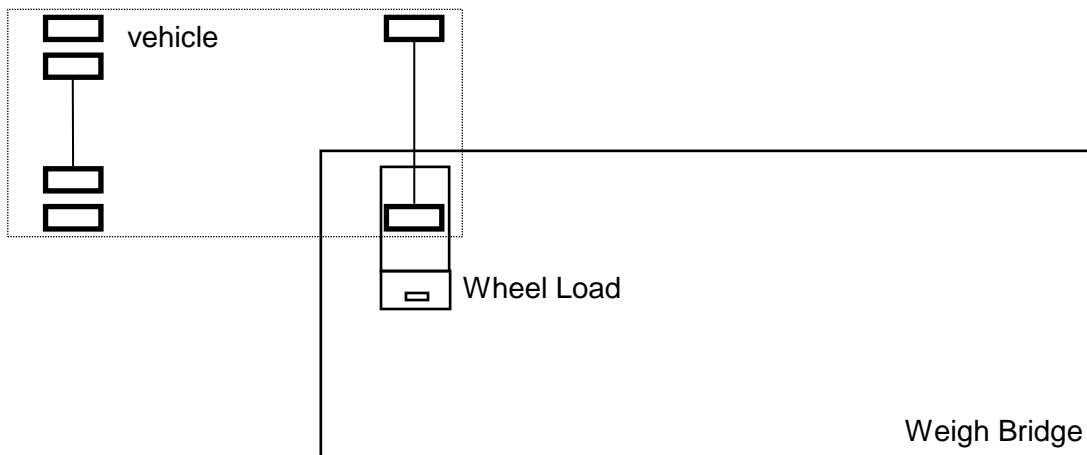

For dynamic scales:

This method **excludes most error influences** due to **unfavourable vehicle and site quality** provided that the **aprons are level with the weigh bridge in order to avoid undue vehicle oscillations!**

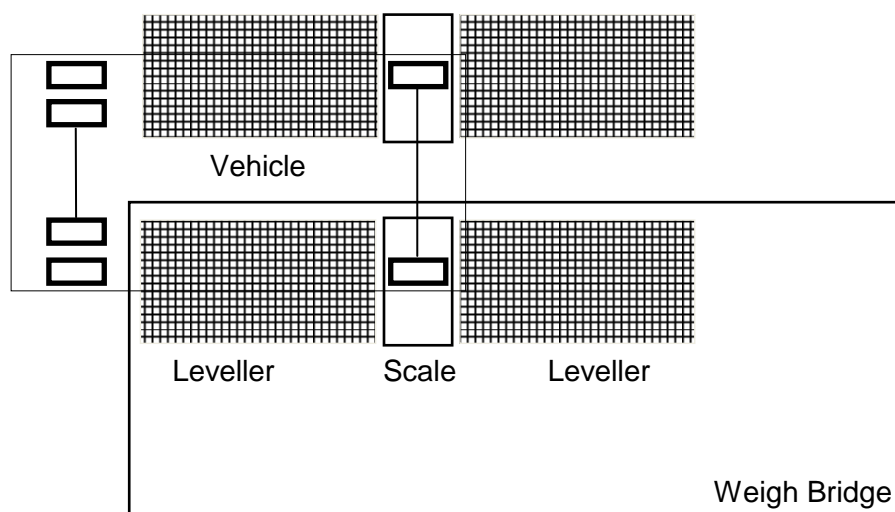

Using a vehicle with known weight (mainly for dynamic scales):

Principle: A vehicle type which is **least sensitive to external errors** is weighed on an approved weighbridge and used as a reference weight for testing a wheel load scale.

A fully loaded truck is weighed on an approved platform scale. A **two axle truck** in perfect technical condition with about 15t gross weight should be used. This kind of vehicle is least sensitive for external errors. Perform 5 weighings on a site with the best possible quality in order to avoid vehicle oscillations. Swap the scales **without changing the cabling**. Perform additional 5 weighings.

Add up all odd wheel weights. These are the results from scale No. 1. Divide by 5. This is the average gross weight measured with the scale No. 1. Do the same with the even wheel weights. These are the results from scale No. 2. The **scale error** is the **difference between the average and the gross weight reading from the weighbridge**.



3.3. Errors caused by external factors

3.3.1. Tilting

Tilting has two effects:

- Tilting of the **vehicle** causes a displacement of the centre of gravity and thus a load shift towards the lower wheels.
- Tilting of the **scale** leads to a lower indication, because the scale only registers the force component rectangular to the scale platform. This effect is very small. At 5% slope the error is only -0.12% of the measured weight!

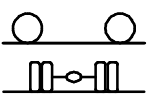
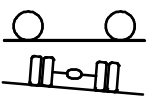
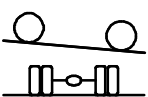
Therefore weighing on a slope shows different results than on a level site. The following table shows the influence:

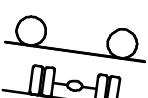
Weighing		gross weight	axle load	wheel load
Gradient				
	lengthwise 0% crosswise 0%	unaffected	unaffected	unaffected
	lengthwise 0% crosswise 5%	unaffected	unaffected	affected ¹⁾
	lengthwise 5% crosswise 0%	unaffected	affected ¹⁾	affected ¹⁾
	total = 5%	unaffected	affected ¹⁾	affected ¹⁾
	total > 5%	not correct ²⁾	not correct ²⁾	not correct ²⁾

- 1) The load of the axle and/or wheels in the lower position is higher than when weighed on a level site, that of the higher axle or wheels correspondingly lower. In the case of vehicles carrying liquid payloads, the effect is compounded by shifting of the load onto lower-lying axle or wheels.
- 2) In the case of gradients steeper than 5 %: same is true as for 5 %, but the differences become proportionally greater. Furthermore, the total weight indicated will be perceptibly smaller (more than -0.12%). If the 5% limit is badly exceeded, the scale may malfunction as well.

For more details refer to P1094

3.3.2. The vehicle suspension

The load a wheel or a axle is carrying is directly related to the compression of the spring of the suspension. This fact is extremely important for a precise weighing of vehicles **with 3 and more axles**.

Errors occur in all cases where a **lifting up** of an axle results in a **compression** of the spring of the suspension. Obviously a two axle truck is not susceptible to such effects. If the front or the rear axle is lifted, the **whole vehicle is tilted** accordingly. The result is, that the suspension does not get more compressed (but rather expanded due to the fact, that the centre of gravity is slightly displaced, reefer to 3.3.1.)

In the case of a three (or more) axle truck it is different. If one axle is lifted, there are still two other axles trying to keep the vehicle in its position. The result is, that the axle is lifted up more, than the vehicle, so that the spring gets more compressed:

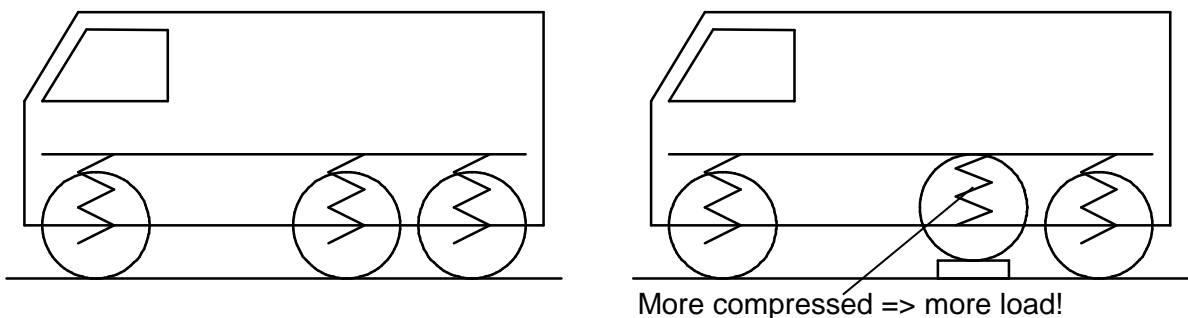

The harder the spring of the suspension the higher the effect. In the case of a rear axle of a truck a rough calculation shows that per mm compression the load rises by approximately 100 kg (Assumption: empty truck: 2t axle load; fully loaded: 12t; difference 10t; compression of the suspension unloaded to fully loaded: 100 mm; Spring rate: 10.000kg/100mm = 100 kg/mm).

Note: Some suspension systems are of the „balancing type“. That means, that a rise of an axle does not inevitably cause an increase of the load. Nevertheless it is strongly recommended to consider all vehicles with three or more wheels as susceptible for uneven level.

The influence of the suspension on the measuring result may be summarised as follows:

- Weighing in one operation (number of scales as number of wheels):
No influence on the gross weight. The axle weights may not be correct if the site is not even. The errors of the axles compensate each other.
- Weighing of axle groups in one operation:
Almost no influence on the axle group load if the front axle is reasonably far away (more than 200 times the height of the scale). Axle weights as above.
- Weighing with two scales axle by axle: All Wheels of an axle group and all wheels closer than 200 times the height of the scale must be exactly on the level of the scale platform. Incorrect levelling and uneven surface influence all results. Because the scales stay at the same position during the weighing the errors do not compensate!

3.3.3. Friction in the suspension

The magnitude of friction forces depends on the construction of the suspension and of its maintenance. A **modern vehicle** in a good as new condition generates **almost no friction forces**, **old and poorly serviced vehicles** may generate friction forces up to 5% of the axle load, which is up to **500 kg** on a 10 t axle. The direction of the friction force is always opposite to the actual movement of the axle. When weighing a wheel the **friction may result in a higher or lower weight**, depending on how the axle movement came to a rest in static weighing, or depending on the actual vertical movement of an oscillating vehicle when passing over the dynamic scale.

The influence of friction on the measuring results is similar to what is described for the suspension itself (3.3.2.). There is no influence when weighing vehicles with two axles. For all other vehicles:

- Weighing in one operation (number of scales as number of wheels):
No influence on the gross weight. The axle weights may not be correct, but the errors compensate each other.
- Weighing of axle groups in one operation:
Almost no influence on the axle group load. Axle weights as above.
- Weighing with two scales axle by axle: In the best case the friction forces are random, because the vehicle oscillation always came to a rest differently at each axle (static), or because the amplitude of the oscillation while passing the dynamic scale was always different. In the worst case the effect is always the same and therefore cumulative.

3.3.4. Brake reaction forces (static weighing only)

Depending on how the braking forces are transferred to the vehicle chassis, the axles may be under tension if the brake is not released. After releasing the brake the vehicle goes into its normal position, provided that there is no friction in the suspension,

To prevent from all unfavourable effects **the driver must release the brake before the reading is taken**. If the site is not perfectly level it is not possible to release the brake for a longer time interval. Therefore two methods for stopping the vehicle are recommended: Brake smoothly, engage the first gear, stop the engine, release the brake or: brake, release, brake. The second way is the most comfortable but also the most risky one: It is not guaranteed, that the break has been released fully and vehicles with many axles may run out of pressure so that the brake does not release any more.

There is no influence if the brake is fully released. But there might be some induced friction by breaking the vehicle. Possible error see (3.3.3.).

3.3.5. Vehicle oscillation (dynamic scales only)

A vehicle in movement is always oscillating more or less in vertical direction. There are two main movements, the oscillation of the **body** with a natural frequency of **1..3 Hz**, depending on the loading and the **axle oscillation** with approximately **10 Hz**. Errors occur because the WIM scale usually is not long enough to measure the axle load during one full period of the lowest frequency (necessary scale length for 10 km/h: 3m!). Depending on the actual amplitude of the oscillation the moment the axle passes the WIM scale the measured weight will be higher or lower than the real static weight. The errors are increasing with the vehicle speed and with the un-evenness of the site. Additional errors up to 5 % at a speed of 10 km/h may occur under unfavorable conditions.

3.3.6. Site unevenness

Site unevenness results in errors due to tilting (3.3.1.), to the suspension (3.3.2.), to friction (3.3.3.) and to vehicle oscillations (3.3.5.)

4. Weighing in practice









The next pages show how to measure with 2, 4, 6 or 8 scales in respect to accuracy and comfort. The following signs are used:

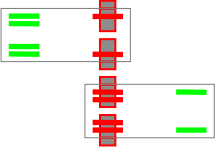
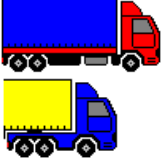

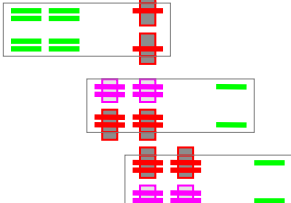

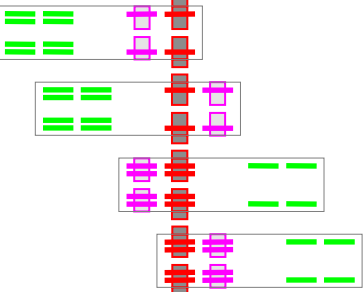
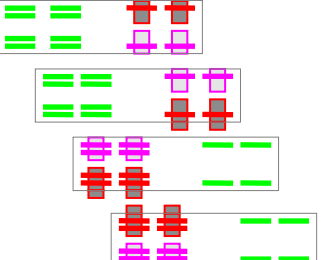
 : Weighed wheel  : levelled wheel  : not weighed wheel

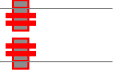
Only the most useful possibilities are shown in the tables.

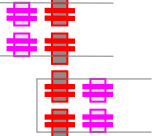
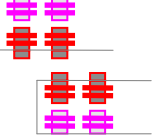
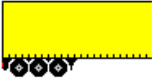
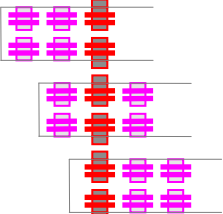
General notes:

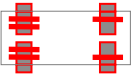
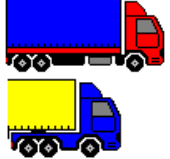
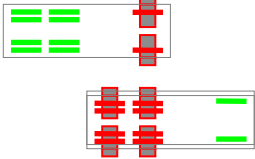
- For dynamic weighing the axle by axle mode using 2 scales is possible only.
- For trailers refer to the truck with the same axle configuration.
- Articulated vehicles are listed as two separate items because in most cases the number of scales is not sufficient for measuring all at once. If enough scales are available the semi-trailer may be measured together with the truck.
- The best comfort is achieved with two scales and 4 large levelling mats because the scales do not have to be dislocated and because the driver has to move the truck onto the platform level with one axle at a time only. The comfort is lower if 4 or more scales and small levelling mats are used because the scales have to be moved around and the driver has to move the truck onto the platform with more than two axles at a time.

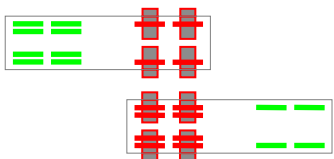
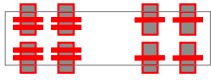
No. of scales / Type of vehicle	Measuring procedure	Comment
2 		<u>Mode:</u> axle by axle <u>Accuracy:</u> very good <u>Comfort:</u> very good
		<u>Mode:</u> axle by axle <u>Accuracy:</u> influenced by the quality of the vehicle and the site ^{2),3)} <u>Comfort:</u> very good ¹⁾
		<u>Mode:</u> front axle, rear axles right / left (static only) <u>Accuracy:</u> good <u>Comfort:</u> low
		<u>Mode:</u> axle by axle <u>Accuracy:</u> influenced by the quality of the vehicle and the site ^{2),3)} <u>Comfort:</u> very good ¹⁾
		<u>Mode:</u> front axles left / right, rear axles right / left (static only) <u>Accuracy:</u> good <u>Comfort:</u> low
		<u>Mode:</u> axle <u>Accuracy:</u> very good <u>Comfort:</u> very good
		<u>Mode:</u> axle by axle <u>Accuracy:</u> influenced by the quality of the vehicle and the site ²⁾³⁾ <u>Comfort:</u> very good ¹⁾
		<u>Mode:</u> right side / left side (static only) <u>Accuracy:</u> good <u>Comfort:</u> low
		<u>Mode:</u> axle by axle <u>Accuracy:</u> influenced by the quality of the vehicle and the site ²⁾³⁾ <u>Comfort:</u> very good ¹⁾

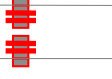
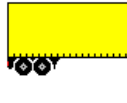
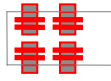
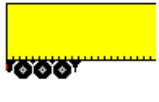
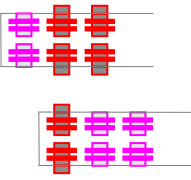
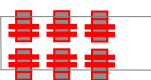
No. of scales / Type of vehicle	Measuring procedure	Comment
4 (6) (8) 		<u>Mode:</u> One operation (static only) <u>Accuracy:</u> very good <u>Comfort:</u> good
4 		<u>Mode:</u> front axle, axle group (static only) <u>Accuracy:</u> good ³⁾ <u>Comfort:</u> good
6 (8)		<u>Mode:</u> One operation (static only) <u>Accuracy:</u> very good <u>Comfort:</u> fairly good
4 (6) 		<u>Mode:</u> axle group by axle group (static only) <u>Accuracy:</u> good ³⁾ <u>Comfort:</u> good
8		<u>Mode:</u> One operation (static only) <u>Accuracy:</u> very good <u>Comfort:</u> sufficient
4 (6) (8) 		<u>Mode:</u> axle <u>Accuracy:</u> very good <u>Comfort:</u> good
		<u>Mode:</u> Axle group (static only) <u>Accuracy:</u> very good <u>Comfort:</u> good
4 		<u>Mode:</u> Axle group, axle (static only) <u>Accuracy:</u> influenced by the quality of the vehicle and the site ²⁾ <u>Comfort:</u> fairly good
6 (8)		<u>Mode:</u> Axle group (static only) <u>Accuracy:</u> very good <u>Comfort:</u> fairly good

1) When using 4 large levelling mats

2) The influence of the site unevenness can be reduced by moving the scales from axle to axle instead of moving the vehicle forward (forward onto the scale, reverse off the scale, static scales only)

3) Short vehicles (spacing to the next axle group less than twice the track width or 200 times the platform height): The non weighed wheels should be levelled for better accuracy.